



Weidmuller 1519760000 SL5.08/4/180B alternative
 Pin Header, Top Entry, Wire-to-Board, 5.08 mm, 1 Rows,
 4 Contacts, Through Hole, SL 5.08

REV	CONTENT	CHK	DATE
V0.0	CONTENT	CXL	20.05.20

Electrical :

- | | | |
|--|-----------------|--------------------|
| | UL | IEC |
| 1. Rated Voltage : | 300V | 320V |
| 2. Rated Current : | 15A | 20A |
| 3. Torque Value : | M2.5 ,3.54Lb.in | M2.5, 0.4N.m |
| 4. Wire Range: | 28-12AWG | 2.5mm ² |
| 5. Stripping Length : | 7-8mm | |
| 6. Withstanding Voltage : | AC1600V/1Min. | |
| 7. Operating Temperature : | -40°C~+105°C | |
| 8. RoHS Compliance | | |
| 9. Safty Approval : | cULus CE | |
| 10. "★" is the key quality control point | | |

GOL2EGTK - 5.08 - XXP - X X - 00

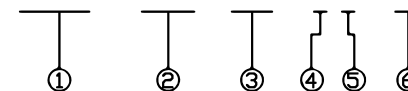

2 Double Pitch

- ② Series NO. ① Single Pitch
- ② Pitch ⑤ Color: Grey
- ③ Poles
- 02 02Contacts
- 03 03Contacts
- ... 24 24Contacts
- 2 Blue
- 3 Black
- 4 Green
- 5 Orange
- 6 Red
- 7 Transparent
- 8 Yellow
- 9 White

⑥ Customer Request: 00--Standard

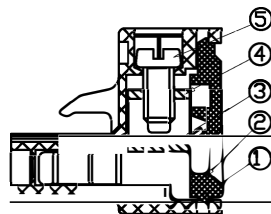
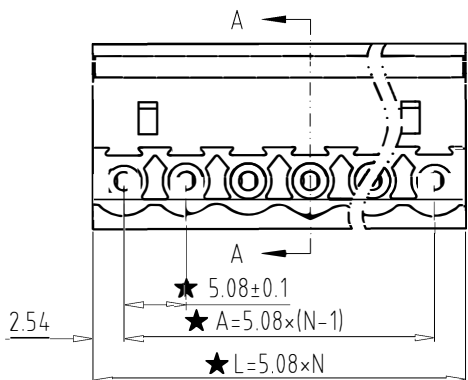
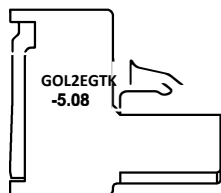
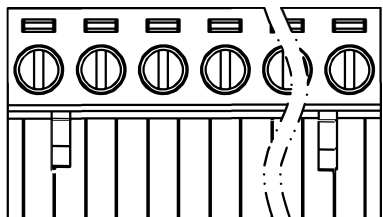
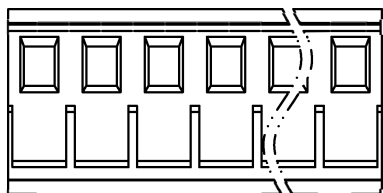

SECTION A-A

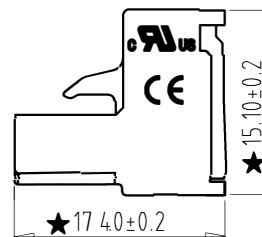

5	SCREW	XX	N	STEEL	Zn Plated
4	BLOCK	XX	N	BRASS	Ni Plated
3	CLAMP	XX	N	PHOSPHOR BRONZE	Ni Plated
2	COVER	XX	1	PA66 UL94V-0	SEE NOTE
1	HOUSING	XX	1	PA66 UL94V-0	SEE NOTE
ITEM	NAME OF PART	NO. OF PART	Q'TY	MATERIAL	NOTE
DWG.	CXL	DATE	20.05.11	SIZE	A4 UNITS mm SHEET/OF 1/1
CHK.		DATE		SCALE	1:1
APP.		DATE		GOL2EGTK-5.08-04P-14-00	
Weidmuller 1519760000 SL5.08/4/180B alternative					
XXXX					

Total Pitch Tolerances in mm										Nominal dimension range in mm										⊥	≡	-	//						
over 0	over 30	over 53	over 70	over 90	over 115	over 150	over 250	over 350	over 500	over 0	over 30	over 53	over 70	over 90	over 115	over 150	over 200	over 250	over 320	over 0	over 10	over 100	over 150	0.2	0.3	0.3	0.2	0.3	0.5
±0.18	±0.20	±0.25	±0.3	±0.35	±0.44	±0.60	±0.70	±0.85	±0.20	±0.25	±0.30	±0.35	±0.44	±0.55	±0.70	±0.80	±0.90	0.2	0.3	0.3	0.2	0.3	0.5						

