



SDS5014M SERIES ~

Low Profile Shielded Power Inductors



RoHS Compliant

PART NUMBERING SYSTEM

SDS	5014M	—	100M	—	LF
TYPE	DIMENSIONS		INDUCTANCE		LEAD FREE

SHAPES AND DIMENSIONS

UNIT : mm

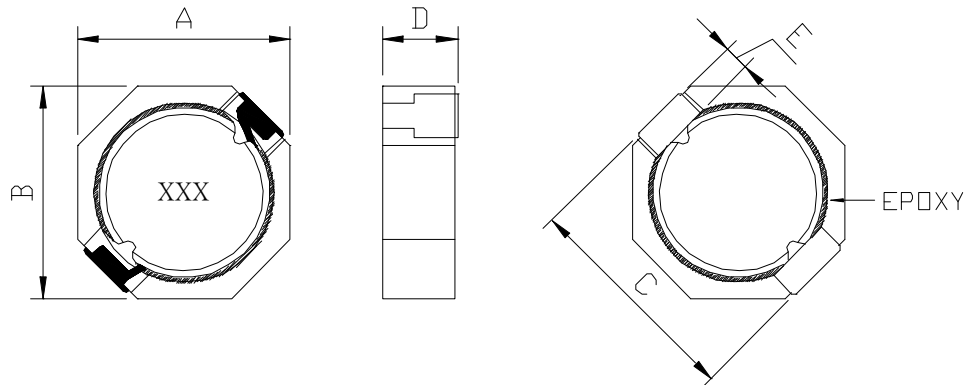

A=5.20 max. B=5.20 max. C=5.60 max. D=1.40 max. E=0.60 REF

RECOMMENDED PATTERNS

UNIT : mm

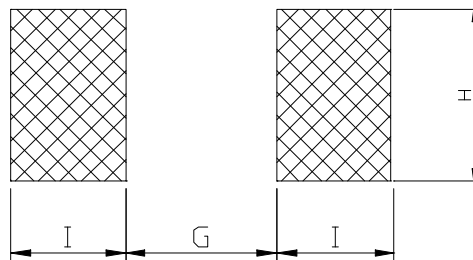

G= 3.40 H= 2.00 I = 1.30

FEATURES

- Low profile (1.40mm max. height) and 5.2mm max. square.
- Magnetically shielded and High Current with low DC resistance .
- Suitable as inductors for Cellular phone .
- Ideal for a variety of DC-DC converter inductor .
- Most suitable for portable electronic equipment requiring low profile and high density mounting .



Coilmaster Electronics Co., Ltd.

9F-3 No.398, Huan Bei Rd. Chung Li City, Taoyuan 320, Taiwan
Tel : +886-3-422-8279 Fax : +886-3-422-8734

E-mail : info@coilmaster.com.tw

Web Site : www.coilmaster.com.tw

SDS5014M SERIES ~

Low Profile Shielded Power Inductors



RoHS Compliant

SPECIFICATION TABLE

PART NUMBER	INDUCTANCE (μ H)	DCR (Ω) (Max.)	Isat (A) (Max.)	Irms (A) (Max.)	TEST FREQ. (f)
SDS5014M-1R5N-LF	1.5 \pm 30%	0.059	2.90	1.70	100KHz
SDS5014M-2R7N-LF	2.7 \pm 30%	0.078	2.20	1.50	100KHz
SDS5014M-4R7N-LF	4.7 \pm 30%	0.13	1.70	1.10	100KHz
SDS5014M-6R8N-LF	6.8 \pm 30%	0.19	1.40	0.99	100KHz
SDS5014M-100M-LF	10 \pm 20%	0.22	1.10	0.92	100KHz
SDS5014M-150M-LF	15 \pm 20%	0.32	0.97	0.80	100KHz
SDS5014M-220M-LF	22 \pm 20%	0.46	0.81	0.62	100KHz
SDS5014M-330M-LF	30 \pm 20%	0.72	0.64	0.50	100KHz
SDS5014M-470M-LF	47 \pm 20%	1.12	0.54	0.41	100KHz
SDS5014M-101M-LF	100 \pm 20%	2.70	0.37	0.26	100KHz

- Isat : DC current at which the inductance drops 30%(typ) from its value without current.
- I rms : : Average current for 40°C temperature rise from 25°C ambient.
- Operating temperature range -40°C to +125°C
- Electrical specifications at 25°C .
- Reel Qty 2,000pcs



SDS5014M SERIES ~

Low Profile Shielded Power Inductors



RoHS Compliant

TYPICAL INDUCTANCE VS. CURRENT

SDS5014M-1R5M-LF

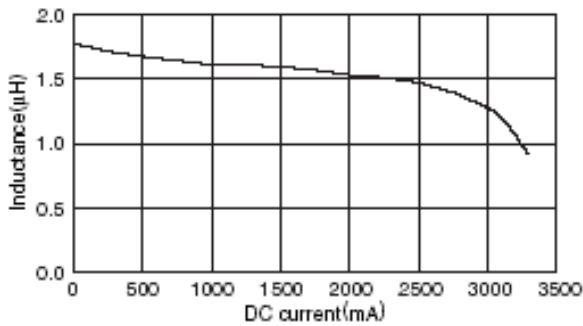

SDS5014M-2R7M-LF

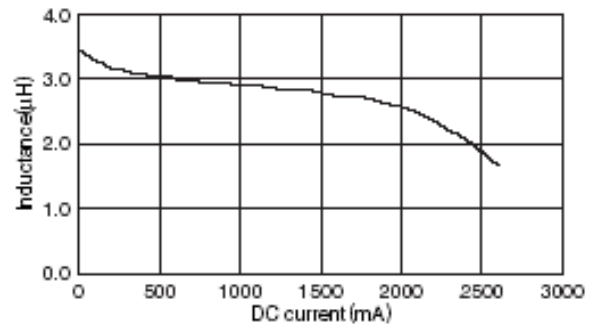

SDS5014M-4R7M-LF

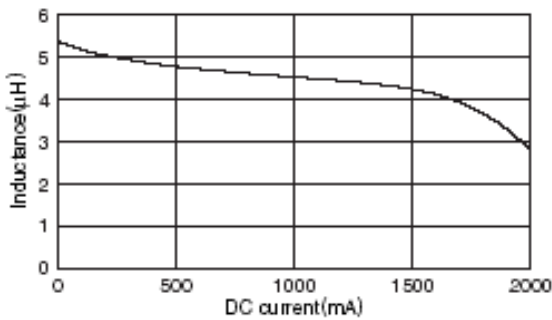

SDS5014M-6R8M-LF

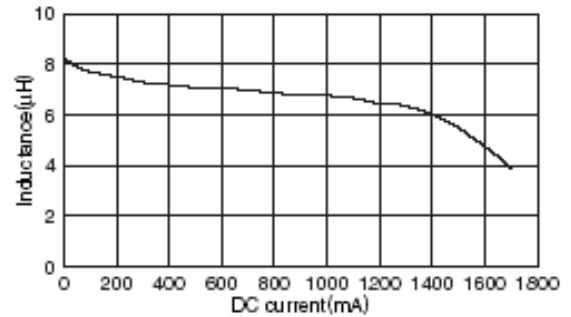

SDS5014M-100M-LF

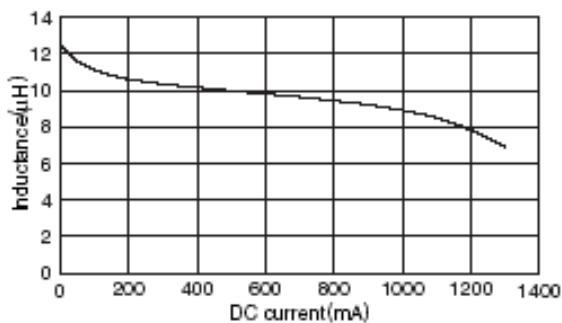

SDS5014M-150M-LF

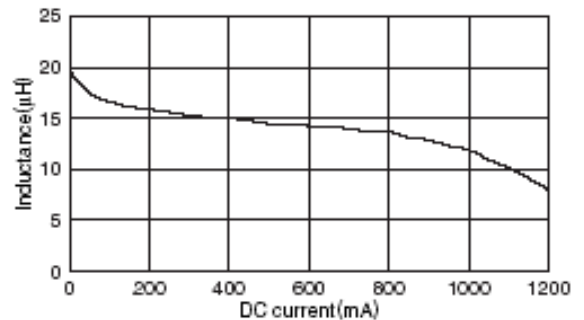



SDS5014M SERIES ~

Low Profile Shielded Power Inductors



RoHS Compliant

TYPICAL INDUCTANCE VS. CURRENT

SDS5014M-220M-LF

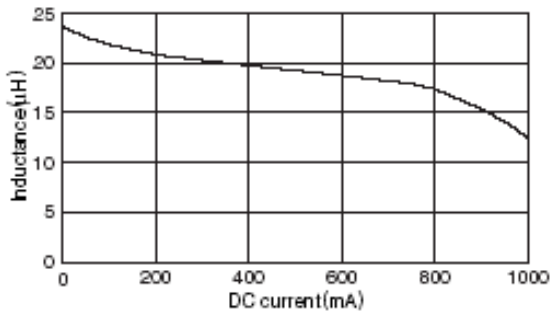

SDS5014M-330M-LF

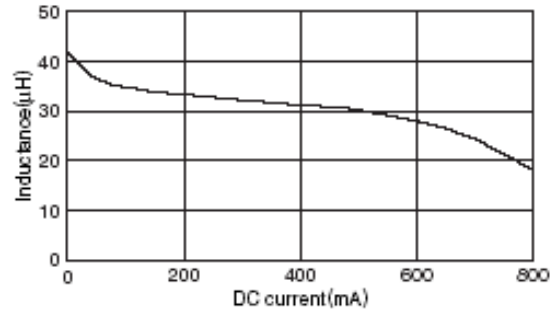

SDS5014M-470M-LF

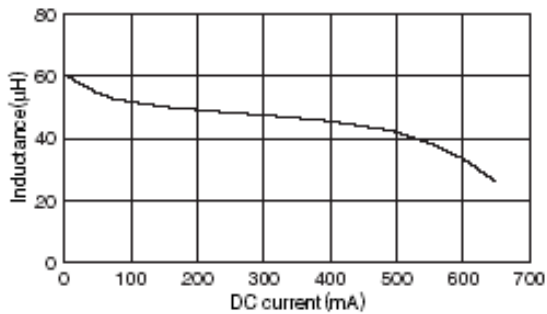

SDS5014M-101M-LF

