



SDS4D12 SERIES

Low Profile Shielded Power Inductors



RoHS Compliant

PART NUMBERING SYSTEM

SDS	4D12	—	6R8N	—	LF
TYPE	DIMENSIONS		INDUCTANCE		LEAD FREE

SHAPES AND DIMENSIONS

UNIT : mm

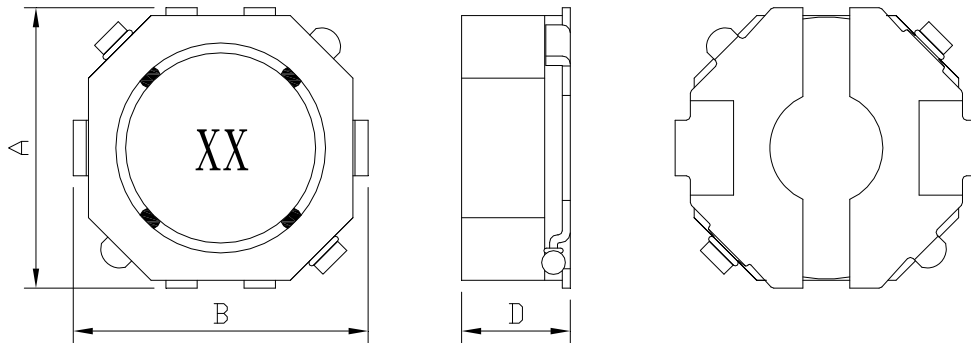

A=4.9 Max. B=4.9 Max. D=1.2 Max.

RECOMMENDED PATTERNS

UNIT : mm

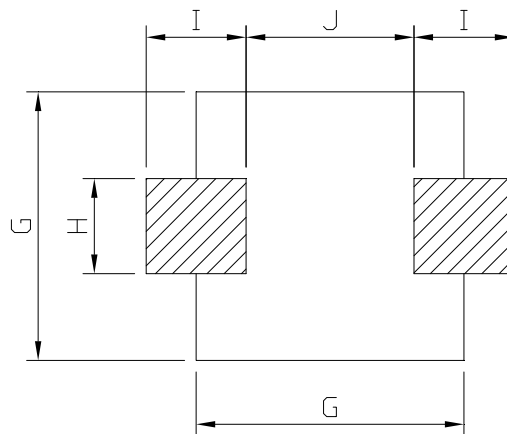

G=5.0 H=1.6 I=1.4 J=2.8



SDS4D12 SERIES

Low Profile Shielded Power Inductors



RoHS Compliant

ELECTRICAL CHARACTERISTICS :

PART NUMBER	INDUCTANCE (μ H)	DCR (m Ω) Max.(Typ.)	Isat (A) (Max.)	Irms (A) (Max.)	Stamp
SDS4D12-1R0N-LF	1.0 \pm 30%	75(60)	2.10	1.70	1R0
SDS4D12-1R5N-LF	1.5 \pm 30%	89(71)	1.80	1.60	1R5
SDS4D12-2R2N-LF	2.2 \pm 30%	106(85)	1.40	1.50	2R2
SDS4D12-2R7N-LF	2.7 \pm 30%	125(100)	1.30	1.40	2R7
SDS4D12-3R3N-LF	3.3 \pm 30%	150(120)	1.20	1.30	3R3
SDS4D12-4R7N-LF	4.7 \pm 30%	196(157)	1.10	1.20	4R7
SDS4D12-5R6N-LF	5.6 \pm 30%	256(205)	1.00	1.05	5R6
SDS4D12-6R8N-LF	6.8 \pm 30%	312(250)	0.90	1.00	6R8
SDS4D12-8R2N-LF	8.2 \pm 30%	362(290)	0.80	0.90	8R2
SDS4D12-100M-LF	10 \pm 20%	450(360)	0.70	0.80	100
SDS4D12-120M-LF	12 \pm 20%	500(400)	0.65	0.75	120
SDS4D12-150M-LF	15 \pm 20%	700(560)	0.60	0.70	150
SDS4D12-180M-LF	18 \pm 20%	775(620)	0.50	0.60	180
SDS4D12-220M-LF	22 \pm 20%	1025(820)	0.45	0.55	220
SDS4D12-270M-LF	27 \pm 20%	1162(930)	0.40	0.50	270
SDS4D12-330M-LF	33 \pm 20%	1300(1040)	0.38	0.45	330
SDS4D12-390M-LF	39 \pm 20%	1500(1200)	0.35	0.43	390
SDS4D12-470M-LF	47 \pm 20%	1625(1300)	0.32	0.40	470

- Inductance tested at 100 kHz, 0.1 Vrms, 0 Adc using an Agilent/HP 4263B LCR meter or equivalent.
- Isat : DC current at which the inductance drops 30% (typ) from its value without current.
- Irms: The actual current when temperature of coil becomes Δ 40°C . (Ta=+25°C)
- Operating temperature range -40°C to +125°C , Electrical specifications at 25°C.
- Packing : 13" reel, machine-ready ,embossed plastic tape (3,000 parts per full reel).