



Coilmaster Electronics Co., Ltd.
9F-3 No.398, Huan Bei Rd. Chung Li City, Taoyuan 320, Taiwan

Email: sales@bec.co.uk
Web: www.bec.co.uk



SEP2512EQ SERIES~ High Current SMD Power Inductors



PART NUMBERING SYSTEM

SEP	2512EQ	—	1R0M	—	LF
TYPE	DIMENSIONS		INDUCTANCE		LEAD FREE

FEATURES :

- Magnetically High Current Power Inductors .
- Low profile (1.2mm max. height) and 2.5 mm (Length) * 2.0mm (Width) compact original design .
- Low DC resistance and Suitable for large current .
- Low acoustic noise and low leakage flux noise by shielded construction .
- Ideal for DC – DC converter inductor application in hand help personal Computer ,etc .
- Halogen Free , 100% lead (Pb) Free and RoHS compliant .

SHAPES AND DIMENSIONS :

UNIT : mm

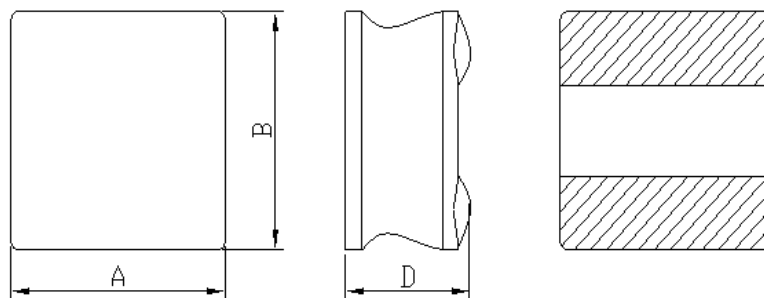

A=2.00±0.3 B=2.50±0.3 C=1.20Max.

RECOMMENDED PATTERNS

UNIT : mm

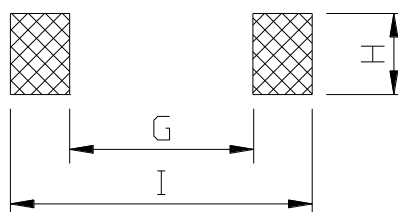

H=2.2 G= 1.1 I = 2.9



SEP2512EQ SERIES~ High Current SMD Power Inductors



SPECIFICATION TABLE

PART NUMBER	INDUCTANCE (μH)	Isat (A) (Typ.)	Irms (A) (Typ.)	DCR (m Ω) (Max.)
SEP2512EQ-R33N-LF	0.33 \pm 30%	7.9	5.9	0.030
SEP2512EQ-R47N-LF	0.47 \pm 30%	6.5	5.6	0.037
SEP2512EQ-R68N-LF	0.68 \pm 30%	5.5	4.4	0.040
SEP2512EQ-1R0M-LF	1.0 \pm 20%	4.4	4.0	0.045
SEP2512EQ-1R2M-LF	1.2 \pm 20%	4.2	3.9	0.070
SEP2512EQ-1R5M-LF	1.5 \pm 20%	3.8	3.3	0.085
SEP2512EQ-2R2M-LF	2.2 \pm 20%	3.1	3.0	0.130
SEP2512EQ-3R3M-LF	3.3 \pm 20%	2.6	2.3	0.170
SEP2512EQ-4R7M-LF	4.7 \pm 20%	2.1	1.9	0.250
SEP2512EQ-100M-LF	10 \pm 20%	1.4	1.2	0.520

- Isat : DC current at which the inductance drops 30% (typ) from its value without current.
- Irms : Average current for a 40°C temperature rise above 25°C ambient.
- Test Frequency at 1MHz / 0.2V
- Operating temperature range -40°C to +125°C , Electrical specifications at 25°C.

PERFORMANCE CURVES

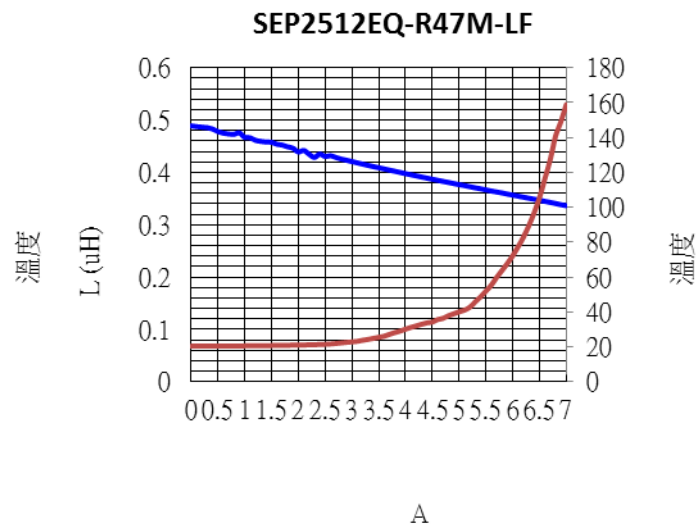
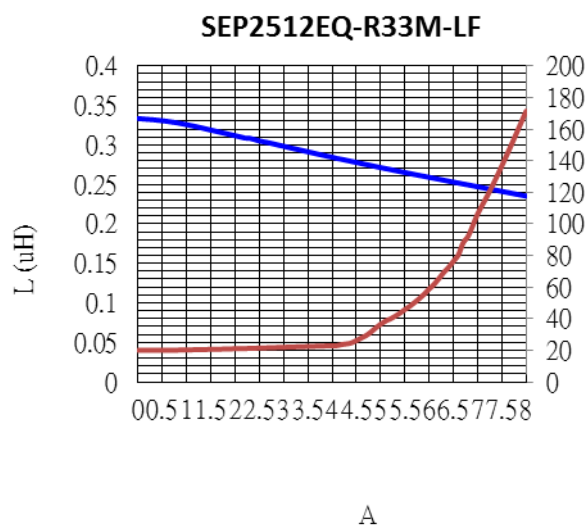



Coilmaster Electronics Co., Ltd.
9F-3 No.398, Huan Bei Rd. Chung Li City, Taoyuan 320, Taiwan

Email: sales@bec.co.uk
Web: www.bec.co.uk



SEP2512ET SERIES~ High Current SMD Power Inductors

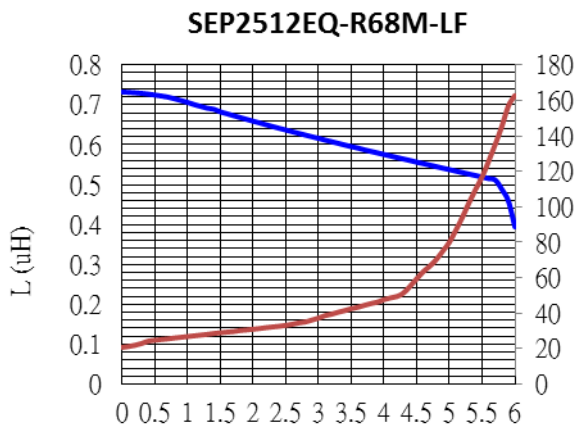

A

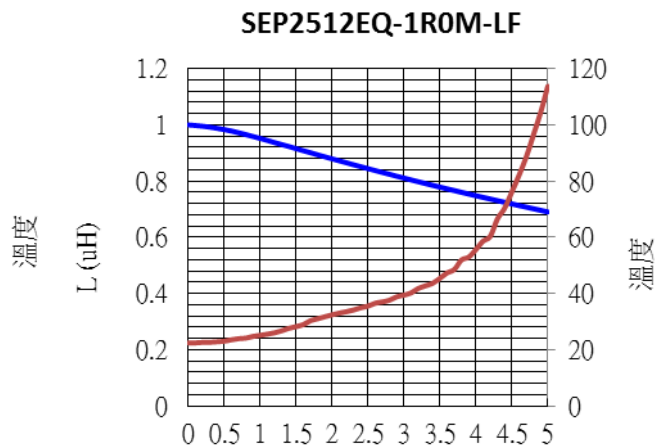

A

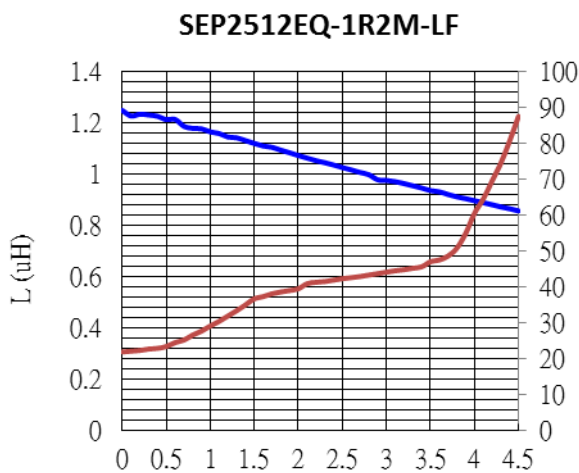

A

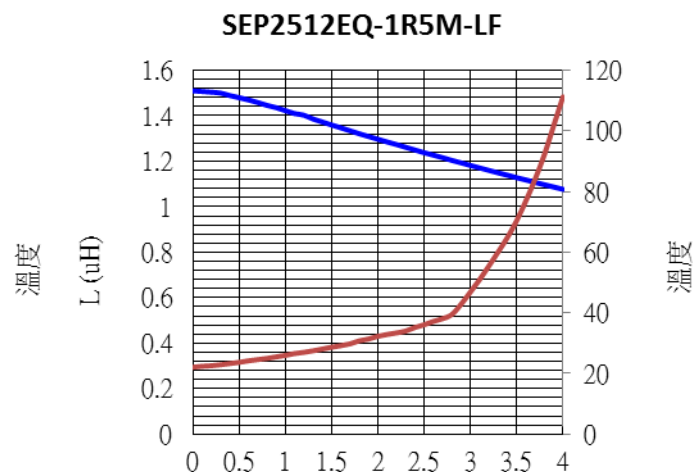

A



Coilmaster Electronics Co., Ltd.
9F-3 No.398, Huan Bei Rd. Chung Li City, Taoyuan 320, Taiwan

Email: sales@bec.co.uk
Web: www.bec.co.uk



SEP2512ET SERIES~ High Current SMD Power Inductors

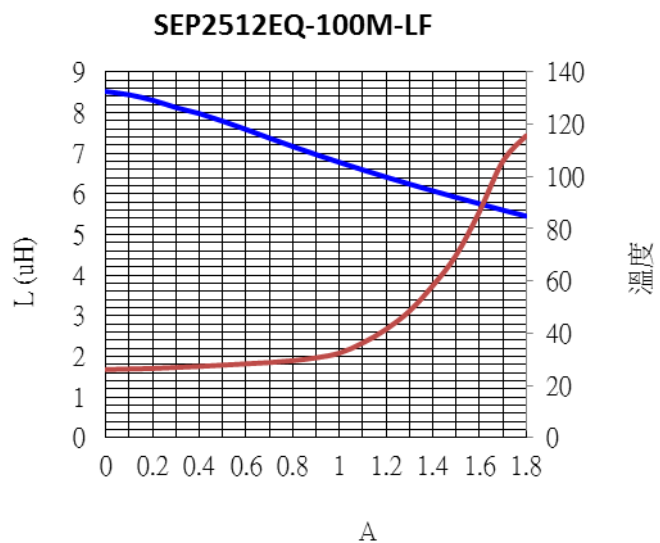
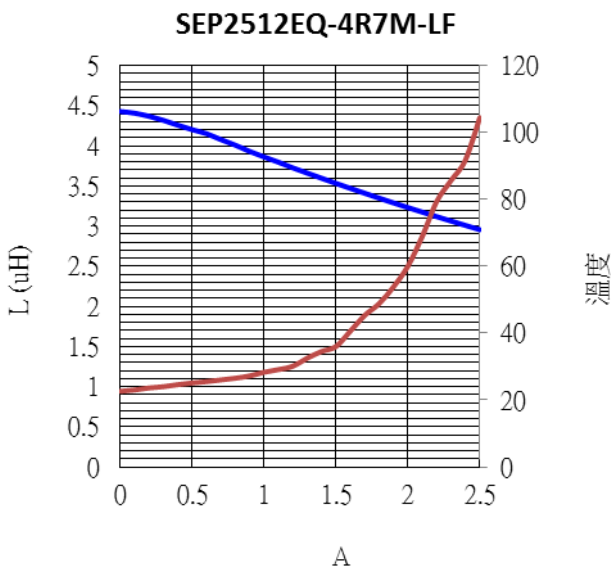
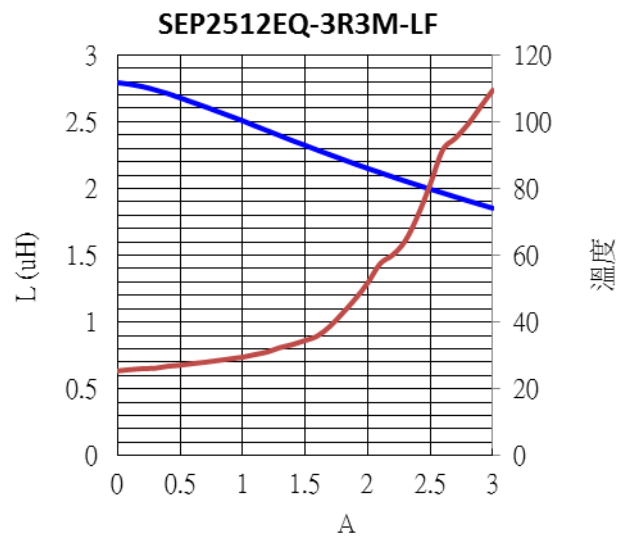
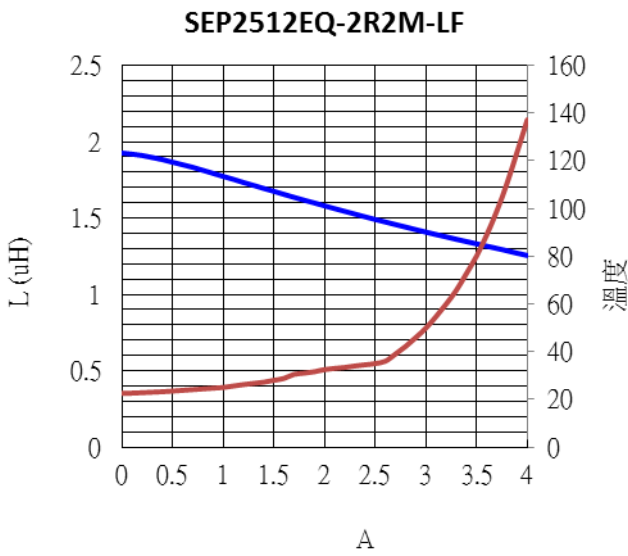



Coilmaster Electronics Co., Ltd.
 9F-3 No.398, Huan Bei Rd. Chung Li City, Taoyuan 320, Taiwan

Email: sales@bec.co.uk
 Web: www.bec.co.uk



SEP2512EQ SERIES~ High Current SMD Power Inductors



PACKAGING SPECIFICATION

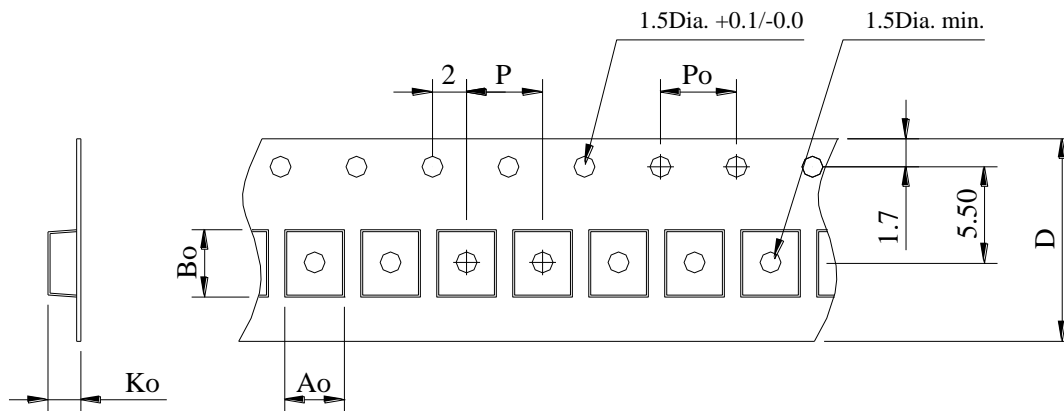

STAYLE	Q'TY (PCS)	DIMENSIONS (m/m)					
		Ao	Bo	Ko	P	Po	D
13"	3,000	2.30±0.1	2.75±0.1	1.3±0.1	4.0±0.1	4.0±0.1	8±0.2